

Varenummer: 025849160088
Beskrivelse: Norma Connect rørkobling
COMBI GRIP GL W2 Ø88,9/90 EPDM 16 bar

Mål

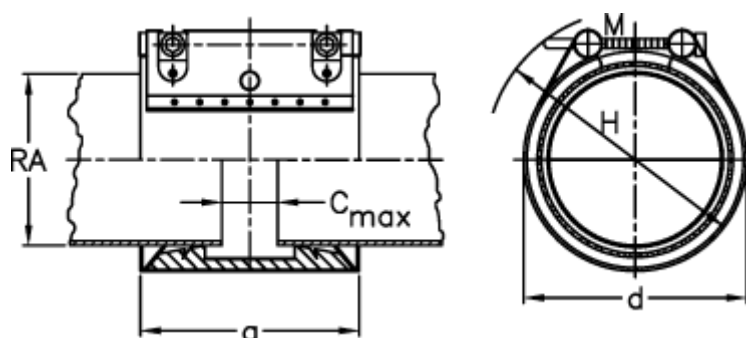

a	= 98.0	RA min-RA max metal = 88,0-90,0
C max med båndindlæg	= 25	Vægt pr stk. = 1.6
d	= 110	
H	= 130	
M (Skrue)	= M10	
Nominelt tryk (bar)	= 16	
RA	= 88,9/90,0	
RA min-RA max kunststof	= 89,0-91,0	